

## Built-in Antenna Low Energy Module

### BT 5 Long Range, Zigbee, Thread, ANT+

This ultra-small LGA module, 8 x 8 x 1 mm, is based on the nRF52840 Chip. Its powerful Cortex™ M4 CPU, flash and RAM memory combined with an optimized antenna offers the perfect solution for Bluetooth connectivity. The solution is best in class for RF performance and low power consumption. Long range and multiple digital and analogue interfaces give optimum flexibility for sensor integration.

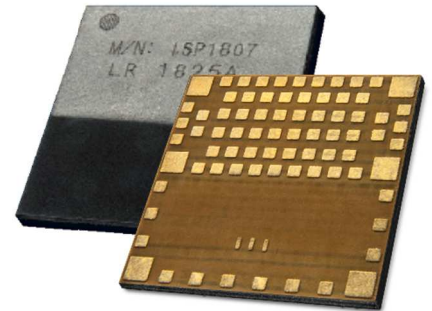

### Key Features

- 2.4GHz Ultra Low Power RF Transceiver
- Full Bluetooth 5 – long range stack  
ANT/ANT+ stack  
2.4 GHz proprietary stack
- BT Mesh, Zigbee, Thread stacks available
- NFC-A Tag for OOB pairing
- Fully integrated RF matching and Antenna
- Integrated 32 MHz & 32kHz Clock
- DC/DC converter with loading circuit
- Based on Nordic Semiconductor nRF52
- 32-bit ARM Cortex M4F CPU
- ARM CryptoCell 310
- 1 MB Flash / 256 kB SRAM
- Configurable 46 GPIOs including 8 ADC
- Many interfaces USB, SPI, UART, PDM, I2C
- Power supply 1.7 to 3.6V, USB supply 5V
- Very small size 8.0 x 8.0 x 1.0 mm
- Temperature -40 to +85 °C
- Pin to Pin compatible with ISP1507

### Applications

- Advanced Wearables: watches, fitness devices, wireless payment wearables, connected health, augmented reality applications ...
- Smart Home sensors and controllers
- Industrial IoT sensors and controllers
- Advanced remote controls
- Remote & Gaming controllers
- Beacons



### Certifications

- Bluetooth SIG certified
- CE certified
- FCC, IC certified
- TELEC, KCC certified
- RoHS and Reach compliant
- Conflict Mineral Declaration

## Revision History

Revision	Date	Ref	Change Description
R0	23/11/2017	cr pg	Preliminary release
R1	12/12/2017	cr pg	Engineering samples release
R2	20/04/2018	cr pg	Section 5.2 – FW tool correction and update Section 6.5 – Extension name change
R3	22/08/2018	cr pg	Section 3 – Typo error correction
R4	12/12/2018	cr pg	Section 2.9 – Schematic updated
R5	18/02/2019	cr pg	Definitive release
R6	14/03/2019	cr pg	Correction VCC / VCCH No High-Power Mode availability
R7	06/06/2019	mm pg	Change to MSL3
R8	08/11/2019	mm pg	Section 4.1 – Mechanical dimension precision Section 8 – Certification list update
R9	17/04/2020	cb pg	Section 4.2 – Assembly guideline precisions Section 8 – Certification list update
R10	03/05/2021	Vn pg	Section 8 – Certification list update
R11	29/04/2022	pd pg	Document layout update

## Contents

---

<b>1.</b>	<b>Block Diagram.....</b>	<b>4</b>
<b>2.</b>	<b>Specifications.....</b>	<b>5</b>
2.1.	Important Notice.....	5
2.2.	Absolute Maximum Ratings.....	5
2.3.	Operating Conditions .....	5
2.4.	Power Consumption.....	6
2.5.	Clock Sources.....	6
2.6.	Radio Specifications.....	6
2.7.	Range Measurement.....	7
2.8.	Antenna Performance .....	7
2.9.	Electrical Schematic.....	9
<b>3.</b>	<b>Pin Description .....</b>	<b>10</b>
<b>4.</b>	<b>Mechanical Outlines.....</b>	<b>13</b>
4.1.	Mechanical Dimensions .....	13
4.2.	SMT Assembly Guidelines .....	15
4.3.	Antenna Keep-Out Zone .....	15
<b>5.</b>	<b>Product Development Tools .....</b>	<b>16</b>
5.1.	Hardware .....	16
5.2.	Firmware.....	16
5.3.	Development Tools .....	17
<b>6.</b>	<b>Packaging &amp; Ordering information .....</b>	<b>18</b>
6.1.	Marking.....	18
6.2.	Prototype Packaging.....	18
6.3.	Jedec Trays .....	18
6.4.	Tape and Reel .....	19
6.5.	Ordering Information .....	20
<b>7.</b>	<b>Storage &amp; Soldering information.....</b>	<b>21</b>
7.1.	Storage and Handling .....	21
7.2.	Moisture Sensitivity .....	21
7.3.	Soldering information .....	22
<b>8.</b>	<b>Quality &amp; User information.....</b>	<b>23</b>
8.1.	Certifications .....	23
8.2.	USA – User information .....	23
8.3.	Canada – User information .....	24
8.4.	RF Exposure Information .....	24
8.5.	Informations concernant l'exposition aux fréquences radio (RF) .....	24
8.6.	Discontinuity.....	24
8.7.	Disclaimer .....	25

## 1. Block Diagram

This module is based on nRF52840 Nordic Semiconductor 2.4GHz wireless System on Chip (SoC) integrating a 2.4 GHz transceiver, an ARM®Cortex® -M4 32-bit processor with 64 MHz FPU, a 1 MB flash memory, a 256 kB RAM and analog and digital peripherals.

It can support BLE, ANT/ANT+ and a range of proprietary 2.4 GHz protocols, such as Gazell from Nordic Semiconductor.

Fully qualified BLE stacks for nRF52840 are implemented in the S140 SoftDevices which can be freely downloaded. ISP1807 can then be used in Bluetooth Central, Peripheral, Observer or Broadcaster role with up to 20 connections and for both ends of other proprietary protocols. nRF52840 platform also provides extensive software support for ANT, ZIGBEE and THREAD applications.

Ultra-low power consumption and advanced power management enables battery lifetimes up to several years on a coin cell battery. Even though its very small size 8 x 8 x 1.0 mm, the module integrates decoupling capacitors, 32 MHz and 32.768 kHz crystals, load capacitors, DC-DC converter, RF matching circuit and antenna in addition to the wireless SoC.

Only the addition of a suitable DC power source is necessary for BLE / ANT / ZIGBEE / THREAD connectivity. Sensor applications require the further addition of appropriate sensors. The antenna was designed to be optimized with several standard ground plane sizes. The NFC tag antenna can be connected externally.

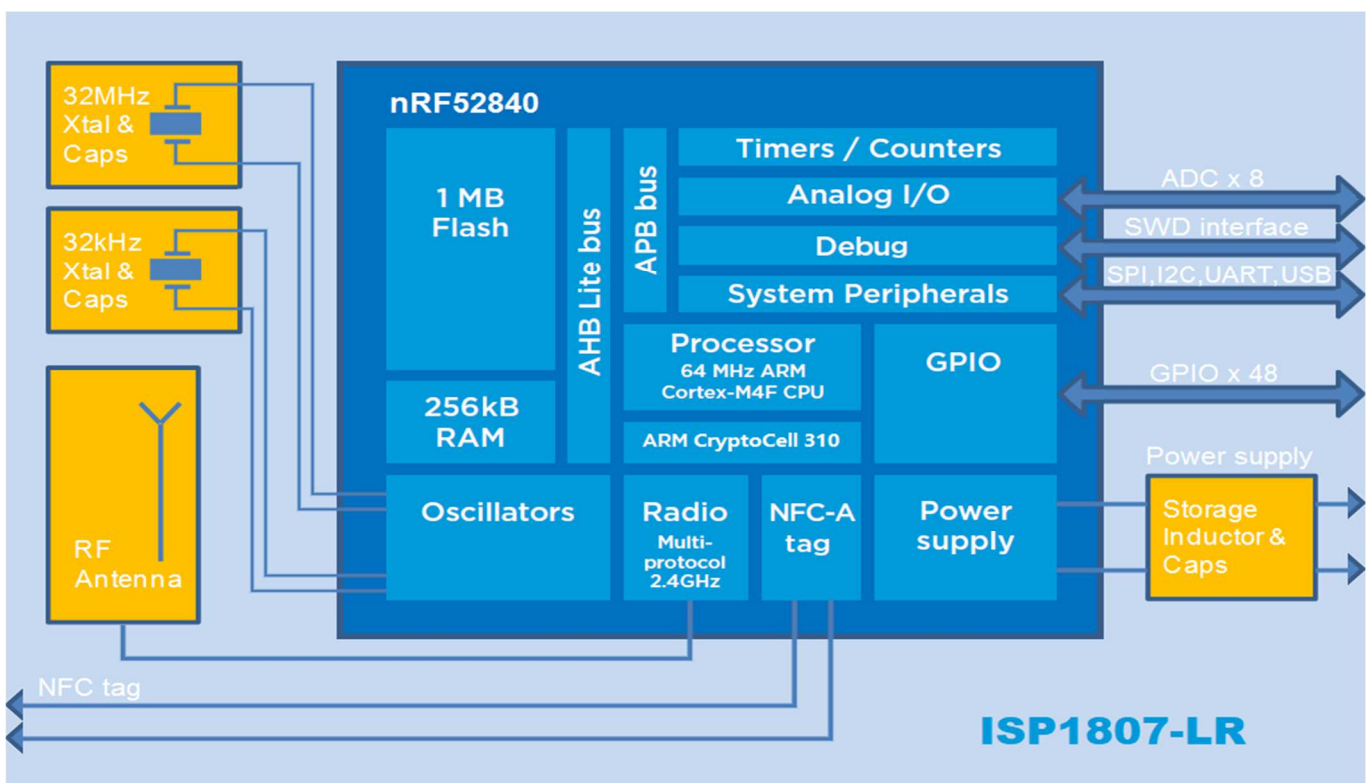

## 2. Specifications

### 2.1. Important Notice

The electrical specifications of the module are directly related to the Nordic Semiconductor specifications for the nRF52840 chipset. Bellow information is only a summary of the main parameters. For more detailed information, especially about current consumption, please refer to the up-to-date specification of the chipset available on Nordic Semi website.

### 2.2. Absolute Maximum Ratings

Parameter	Min	Typ	Max	Unit
Main Supply Voltage respect to ground – VCC_nRF	-0.3		3.9	V
USB Supply Voltage respect to ground – VBUS	-0.3		5.8	V
IO Pin Voltage	-0.3		3.9	V
RF Input Level			10	dBm
NFC Antenna pin current			80	mA
Storage Temperature	-40		+125	°C
Moisture Sensitivity Level			5	-
ESD Human Body Model			4000	V
ESD Charged Device Model			750	V
Flash Endurance			10000	cycles

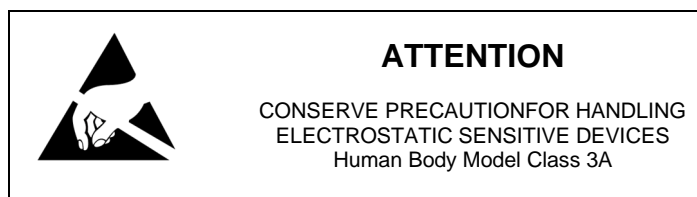

### 2.3. Operating Conditions

Parameter	Min	Typ	Max	Unit
VCC_nRF Supply Voltage, independent of DCDC enable	1.7	3.0	3.6	V
VBUS Supply Voltage	4.35	5.0	5.5	V
Extended Industrial Operating Temperature Range	-40	+25	+85	°C

## 2.4. Power Consumption

Parameter	Min	Typ	Max	Unit
Peak Current, Transmitter +8 dBm, VCC 3V + DCDC		16.4		mA
Peak Current, Transmitter 0 dBm, VCC 3V + DCDC		6.4		mA
Peak Current, Receiver 1 Mbps, VCC 3V + DCDC		6.26		mA
System OFF, no RAM retention		0.4		µA
System ON, no RAM retention, wake on RTC		1.5		µA
Additional RAM retention current per 4 KB block		30		nA

## 2.5. Clock Sources

Parameter	Min	Typ	Max	Unit
Internal High Frequency Clock for RF Stability: 32 MHz Crystal Frequency Tolerance <sup>(1)</sup>			+/- 40	ppm
Internal Low Frequency Clock for BLE Synchronization: 32.768 kHz Crystal Frequency Tolerance <sup>(1)</sup>			+/- 40	ppm
Internal Low Frequency Clock for BLE Synchronization: RC Oscillator <sup>(2)</sup>			+/- 250	ppm
RF Frequency Tolerance for BLE Operation			+/- 40	ppm

(1) including initial tolerance, drift, aging, and frequency pulling

(2) Frequency tolerance after calibration

## 2.6. Radio Specifications

Parameter	Min	Typ	Max	Unit
Frequency Range	2402		2480	Mhz
Maximum Output Power		+8	+8.5	dBm
Rx Sensitivity Level, BLE1 Mbps		-95		dBm
Rx Sensitivity Level, BLE Long Range 125 kbps		-103		dBm
Antenna Gain		0.6		dBi
EIRP	-19.4		8.6	dBm
Data Rate	125		2000	kbps

## 2.7. Range Measurement

Range measurement between ISP1807-LR test board (configured as Central) and ISP1807-LR test board (configured as Peripheral).

Parameter	Min	Typ	Max	Unit
Range Open field @1m height (0 dBm, 1 Mbps)		150		m
Range Open field @1m height (0 dBm, 125 Kbps)		175		m
Range Open field @1m height (8 dBm, 1 Mbps)		230		m
Range Open field @1m height (8 dBm, 125 Kbps)		450		m

## 2.8. Antenna Performance

### Typical Antenna Return Loss

Module mounted on a USB dongle ground plane

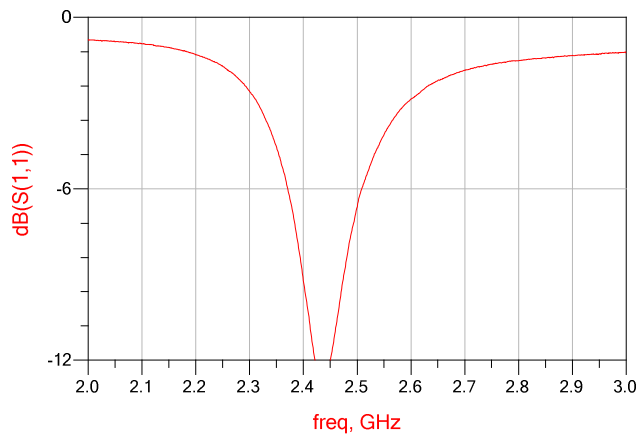

### Radiation Pattern in 3 planes

Module mounted on a USB dongle ground plane

Gain measurement in dBi in the BLE band from 2.4 to 2.5 GHz.

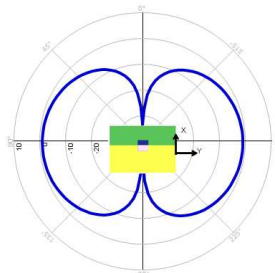
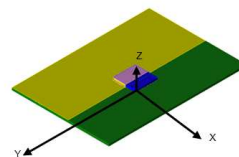

Phi (0.000 to 360.000)

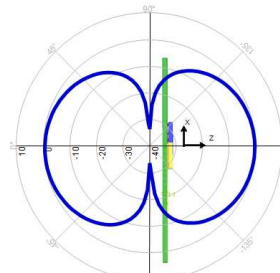

Théta (-180.000 to 180.000)

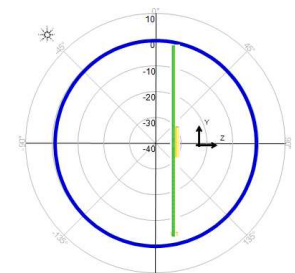

Théta (-180.000 to 180.000)

**Ground Plane Effect Simulation**

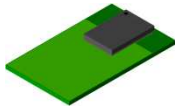

USB dongle ground plane  
(size: 18 x 30 mm<sup>2</sup>)

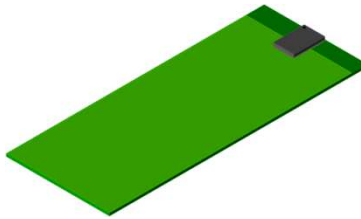

Cell phone config 1 ground plane  
(size: 40 x 100 mm<sup>2</sup>)

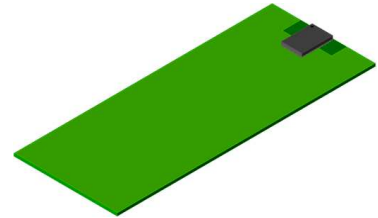

Cell phone config 1 with side ground plane  
(size: 40 x 100 mm<sup>2</sup>)

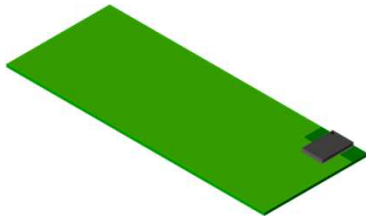

Cell phone config 2 with side ground plane  
(size: 40 x 100 mm<sup>2</sup>)

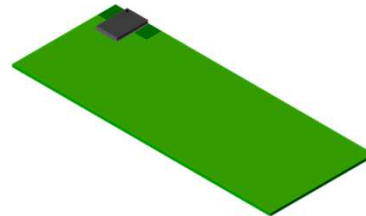

Cell phone config 3 with side ground plane  
(size: 40 x 100 mm<sup>2</sup>)

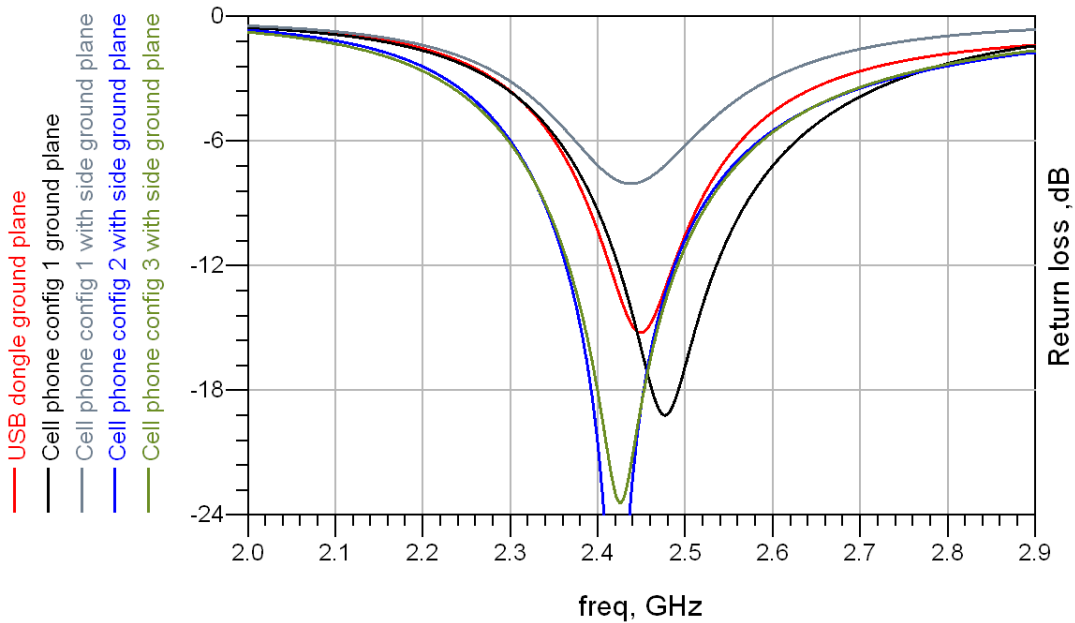



**2.9. Electrical Schematic**

Electrical schematic showing  
ISP1807 module connections

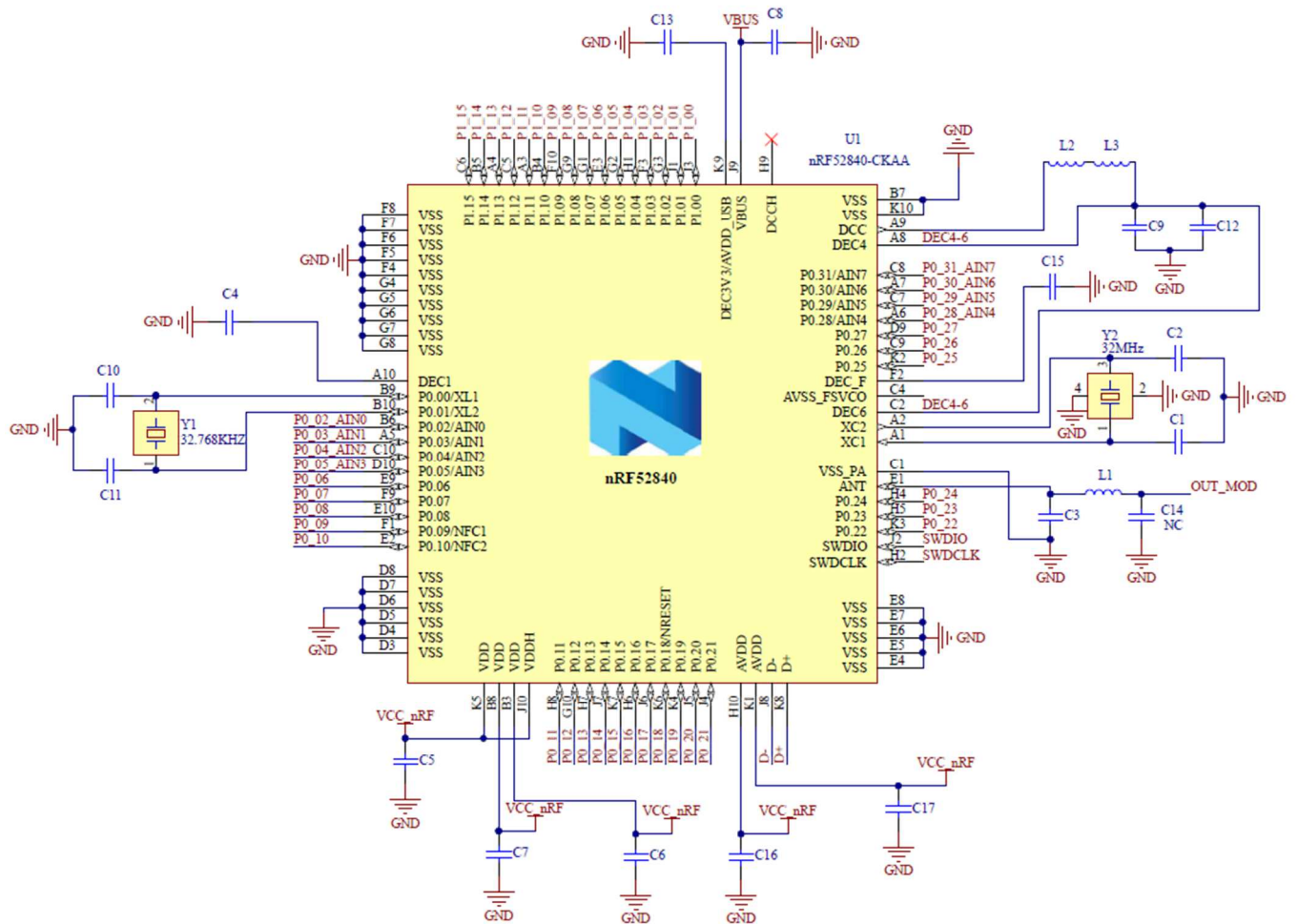

### 3. Pin Description

The module uses an LGA format with a double row of pads on a 0.65 mm pitch. The pad layout follows the QFN Jedec standard for 2 row LGA parts. The NC pads are to be connected to isolated metal pads on the application PCB for mechanical stability and reliability (drop test).

Pin	Name	Pin function	Description
1	VSS	Ground	Should be connected to ground plane on application PCB
2	P0_09 NFC1	Digital I/O NFC Input	General purpose I/O pin NFC antenna connection
3	P0_12 TRACEDATA1	Digital I/O	General purpose I/O pin Trace port output
4	P0_10 NFC2	Digital I/O NFC Input	General purpose I/O pin NFC antenna connection
5	P0_14	Digital I/O	General purpose I/O pin
6	P0_26	Digital I/O	General purpose I/O pin
7	VSS	Ground	Should be connected to ground plane on application PCB
8	D+	Digital I/O	USB D+
9	P0_16	Digital I/O	General purpose I/O pin
10	D-	Digital I/O	USB D-
11	P0_21	Digital I/O	General purpose I/O pin
12	VBUS	Power	5V input for USB 3.3V regulator
13	P0_18 RESET	Digital I/O	General purpose I/O pin Configurable as system RESET pin
14	VSS	Ground	Should be connected to ground plane on application PCB
15	P0_20	Digital I/O	General purpose I/O pin
16	VSS	Ground	Should be connected to ground plane on application PCB
17	P0_22	Digital I/O	General purpose I/O pin
18	VSS	Ground	Should be connected to ground plane on application PCB
19	P0_24	Digital I/O	General purpose I/O pin
20	OUT_ANT	Antenna I/O	This pin is connected to the internal antenna It should be connected to Pin 22 OUT_MOD for normal operation
21	VSS	Ground	Should be connected to ground plane on application PCB
22	OUT_MOD	Antenna I/O	This pin is the RF I/O pin of the BLE module It should be connected to Pin 20 OUT_ANT for normal operation
23	VSS	Ground	Should be connected to ground plane on application PCB
24	VSS	Ground	Should be connected to ground plane on application PCB
25	VSS	Ground	Should be connected to ground plane on application PCB
26	VCC_nRF	Power	Power supply (1.7 – 3.6V)
27	P0_17	Digital I/O	General purpose I/O pin
28	SWDIO	Digital I/O	Serial Wire Debug I/O for debug and programming
29	P0_13	Digital I/O	General purpose I/O pin
30	SWDCLK	Digital Input	Serial Wire Debug clock input for debug and programming
31	VSS	Ground	Should be connected to ground plane on application PCB
32	P0_08	Digital I/O	General purpose I/O pin
33	P0_07 TRACECLK	Digital I/O	General purpose I/O pin Trace port clock output

Pin	Name	Pin function	Description
34	P0_06	Digital I/O	General purpose I/O pin
35	P0_04 AIN2	Digital I/O Analog Input	General purpose I/O pin SAADC/COMP/LPCOMP input
36	P0_05 AIN3	Digital I/O Analog Input	General purpose I/O pin SAADC/COMP/LPCOMP input
37	P0_15	Digital I/O	General purpose I/O pin
38	P0_03 AIN1	Digital I/O Analog Input	General purpose I/O pin SAADC/COMP/LPCOMP input
39	P0_27	Digital I/O	General purpose I/O pin
40	P0_02 AIN0	Digital I/O Analog Input	General purpose I/O pin SAADC/COMP/LPCOMP input
41	P0_25	Digital I/O	General purpose I/O pin
42	P0_31 AIN7	Digital I/O Analog Input	General purpose I/O pin SAADC/COMP/LPCOMP input
43	P0_11 TRACEDATA2	Digital I/O	General purpose I/O pin Trace port output
44	P0_30 AIN6	Digital I/O Analog Input	General purpose I/O pin SAADC/COMP/LPCOMP input
45	P0_19	Digital I/O	General purpose I/O pin
46	P0_29 AIN5	Digital I/O Analog Input	General purpose I/O pin SAADC/COMP/LPCOMP input
47	P0_23	Digital I/O	General purpose I/O pin
48	P0_28 AIN4	Digital I/O Analog Input	General purpose I/O pin SAADC/COMP/LPCOMP input
49	P1_02	Digital I/O	General purpose I/O pin
50	P1_06	Digital I/O	General purpose I/O pin
51	P1_15	Digital I/O	General purpose I/O pin
52	P1_14	Digital I/O	General purpose I/O pin
53	P1_13	Digital I/O	General purpose I/O pin
54	P1_05	Digital I/O	General purpose I/O pin
55	P1_08	Digital I/O	General purpose I/O pin
56	P1_09 TRACEDATA3	Digital I/O	General purpose I/O pin Trace port output
57	P1_00 TRACEDATA0	Digital I/O	General purpose I/O pin Trace port output
58	P1_03	Digital I/O	General purpose I/O pin
59	P1_12	Digital I/O	General purpose I/O pin
60	P1_10	Digital I/O	General purpose I/O pin
61	P1_11	Digital I/O	General purpose I/O pin
62	P1_07	Digital I/O	General purpose I/O pin
63	P1_04	Digital I/O	General purpose I/O pin
64	P1_01	Digital I/O	General purpose I/O pin
65 to 78	NC	Not Connected	Isolated pad on application PCB for mechanical stability

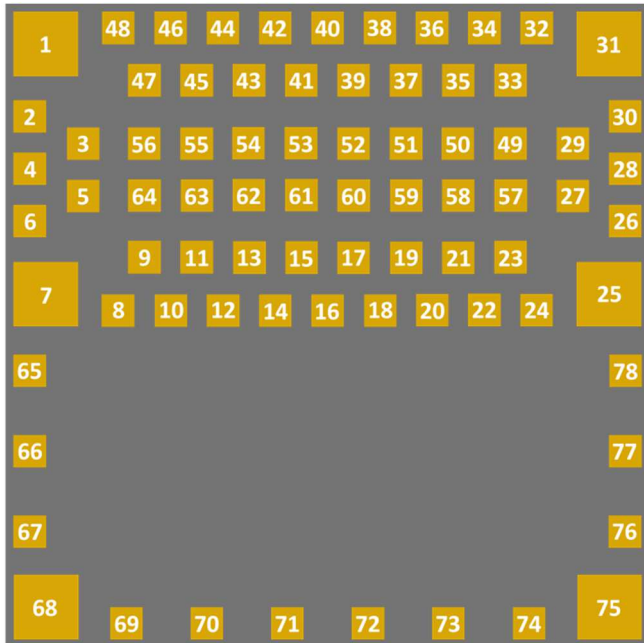

ISP1807  
pad placement and pin assignment  
for the LGA QFN package

TOP VIEW

## 4. Mechanical Outlines

---

### 4.1. Mechanical Dimensions

Package dimensions

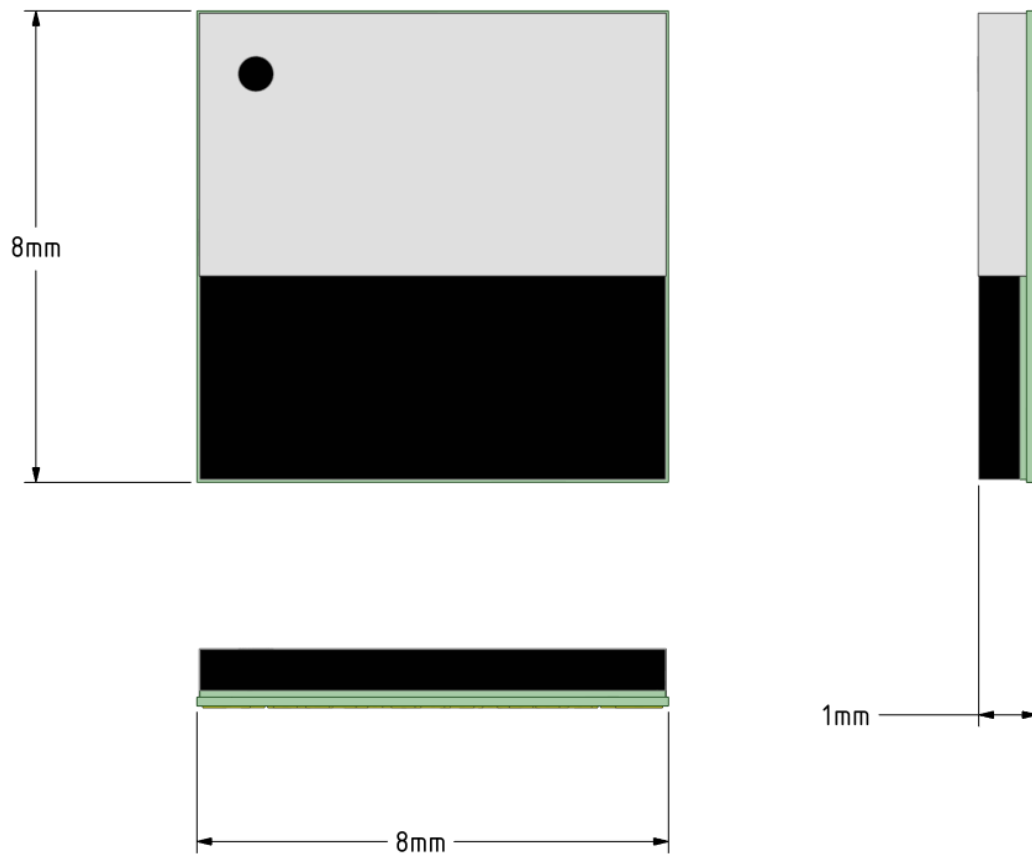

Dimensional drawing for 62-Pad LGA Package

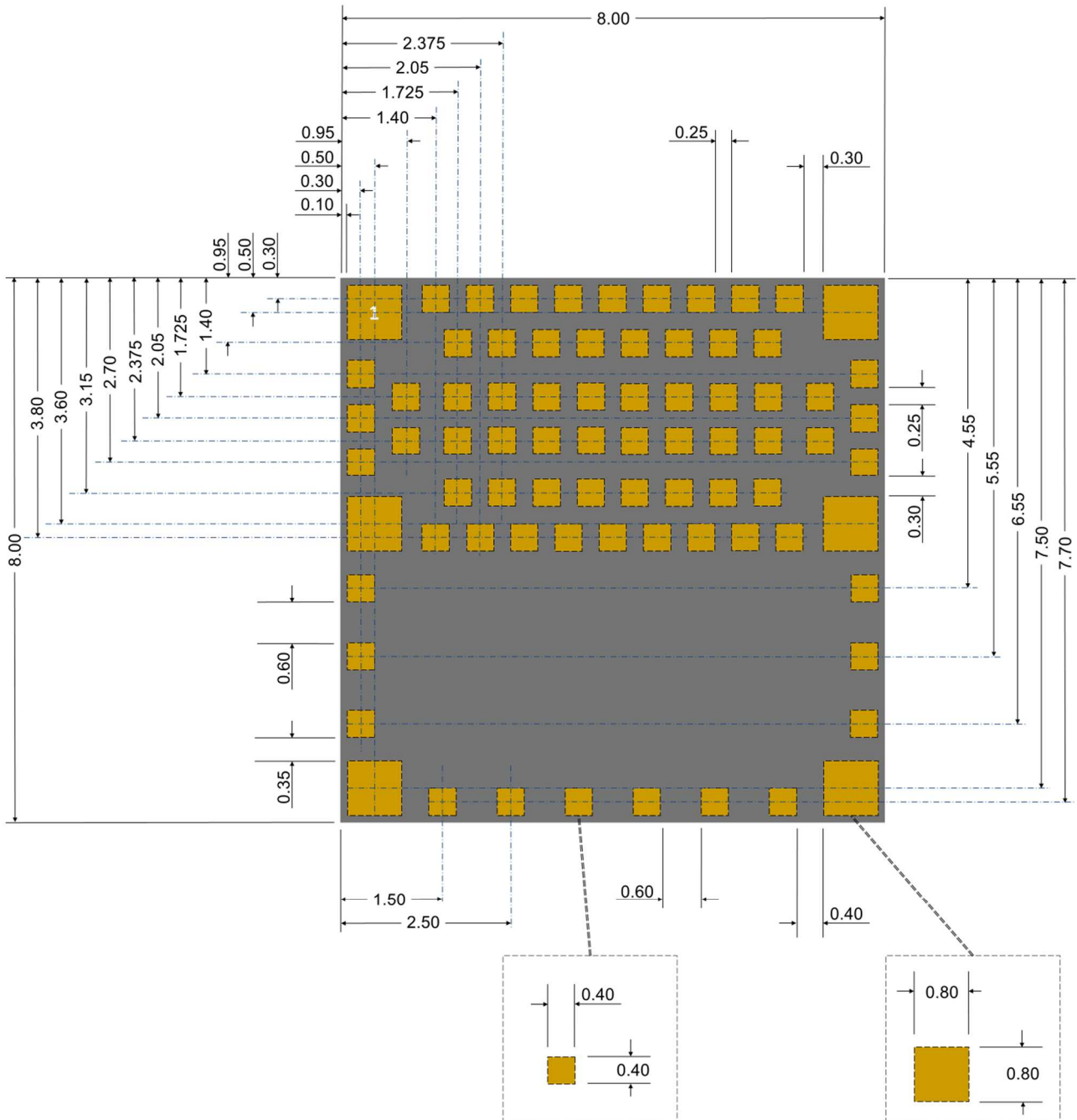

### 4.2. SMT Assembly Guidelines

For PCB Land Patterns and Solder Mask layout, Insight SiP recommends using the same dimensions as module pads, ie 0.4 x 0.4 mm for standard pads and 0.8 x 0.8 mm for corner pads.

For implementations in which most or all of the inner pads are used Insight SiP recommends the use of capped vias placed in the centre of each pad.

For standard PCB types (no micro vias - all vias are top to bottom): we use nominal 0.4mm catch pads with 0.2mm vias. The vias should be plugged and capped to avoid solder wicking.

For HDI PCB types having micro vias on a layer by layer basis: we use 0.25mm catch pads and 0.1mm copper filled laser vias. Ideally the via is centered in the pad.

For reduced pinout implementations we recommend using external pads only. The use of a small number of internal pads can be accommodated by placing normal vias in the centre of the device. In this case only the required pads should be Solder Mask opened and the vias tented with solder mask to prevent short circuits.

In general, we recommend NSMD solder mask with 50µm SM extension.

### 4.3. Antenna Keep-Out Zone

For optimal antenna performance, it is recommended to respect a metal exclusion zone to the edge of the board: no metal, no traces and no components on any application PCB layer except mechanical LGA pads.

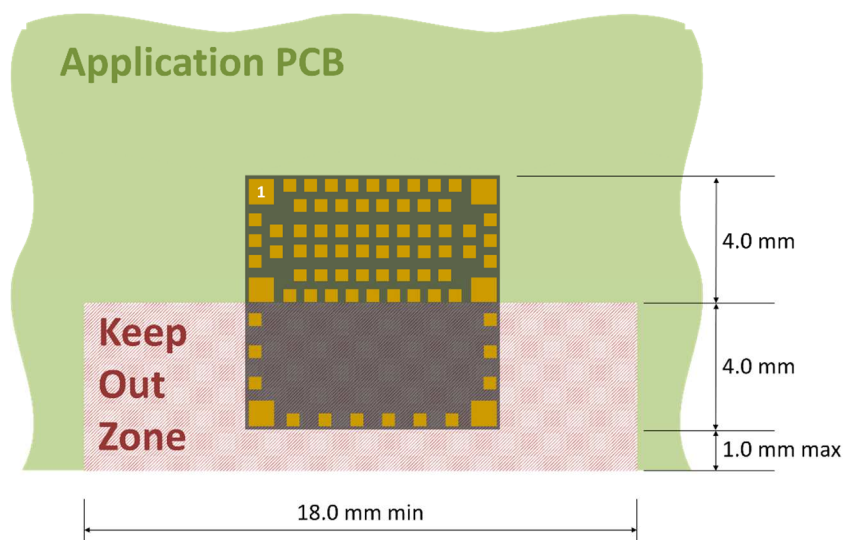

## 5. Product Development Tools

---

### 5.1. Hardware

In order to assist clients in developing their Bluetooth Smart solutions based on the ISP1807, Insight SIP offers a Development Kit containing:

- One Interface Board
- J-Link Lite CortexM-9 JTAG/SWD Emulator
- One Test Board
- A Development Dongle
- 5 ISP1807 module samples
- Cables, power supply and coin battery holder

Using this development kit, product developers can use a working solution as starting point to develop their own products. Time to market is saved by avoiding starting from a blank sheet of paper. In addition, there may be some applications that use the hardware as is.

Please refer to the documentation for more information:

[http://www.insightsip.com/fichiers\\_insightsip/pdf/ble/ISP1807/isp\\_ble\\_DS1807\\_DK.pdf](http://www.insightsip.com/fichiers_insightsip/pdf/ble/ISP1807/isp_ble_DS1807_DK.pdf)

### 5.2. Firmware

ISP1807 supports Bluetooth Low Energy protocol stacks. It also provides extensive software support for ANT, ZIGBEE and THREAD applications as well as 2.4 GHz protocol stacks, including Gazell. All are available as downloads at [www.nordicsemi.com](http://www.nordicsemi.com).

✚ The S140 SoftDevice is a Bluetooth low energy (BLE) Central and Peripheral protocol stack solution. The S140 SoftDevice supports up to twenty connections with an additional observer and a broadcaster role all running concurrently.

The S140 SoftDevice integrates a Bluetooth low energy Controller and Host, and provides a full and flexible API for building Bluetooth low energy nRF52 System on Chip (SoC) solutions:

- Bluetooth 5.0 compliant low energy single-mode protocol stack suitable for Bluetooth low energy products.
- Concurrent central, observer, peripheral, and broadcaster roles with up to 20 concurrent connections along with one Observer and one Broadcaster.
- Link layer supporting LE 1M PHY and LE 2M PHY.
- LL Privacy.
- LE Data Packet Length Extension.
- LE Secure Connections pairing model



### 5.3. Development Tools

The following development tools and software are recommended for using and testing ISP1807 module:

- ✚ Nordic Semiconductor nRFgo Studio:  
Downloadable after registering at [www.nordicsemi.com](http://www.nordicsemi.com).
- ✚ Nordic Semiconductor Master Control Panel:  
Downloadable after registering at [www.nordicsemi.com](http://www.nordicsemi.com).
- ✚ Keil MDK-ARM Lite:  
Downloadable from <https://www.keil.com/demo/eval/arm.htm>.
- ✚ Segger J-Link Lite:  
Downloadable from <http://www.segger.com/jlink-software.html>.
- ✚ nRF52 Software Development Kit (SDK):  
nRF52 SDK can be downloaded after registering at [www.nordicsemi.com](http://www.nordicsemi.com). It contains example of source codes applications (C language):
  - Precompiled HEX files
  - Source code
  - Keil ARM project files
  - IAR project files

## 6. Packaging & Ordering information

### 6.1. Marking

M	/N	:	I	S	P	1	8	0	7
T	T		Y	Y	W	W	R		

ISP1807	Part Number
TT	2 letters Module Type (see section 6.5)
YY	2 digits year number
WW	2 digits week number
R	1 letter Hardware revision

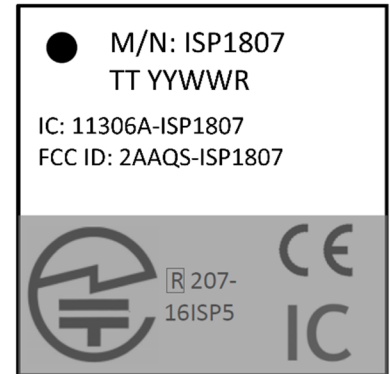

### 6.2. Prototype Packaging

For engineering samples and prototype quantities up to 99 units, deliveries are provided in thermoformed trays or cut tapes.

They are delivered in sealed pack with desiccant pack and humidity sensors. Please see section 7.2 for more information on moisture sensitivity.

Please order with “ST” code packaging suffix.



### 6.3. Jedec Trays

For pre-production volumes, ISP1807 are available in Jedec trays. They are delivered in sealed pack with desiccant pack and humidity sensors. These Jedec trays are also suitable for further baking. Please see section 7.2 for more information on moisture sensitivity. Please order with “JT” code packaging suffix.

Refer to tray sizes below. Complete information on Jedec trays is available on request.

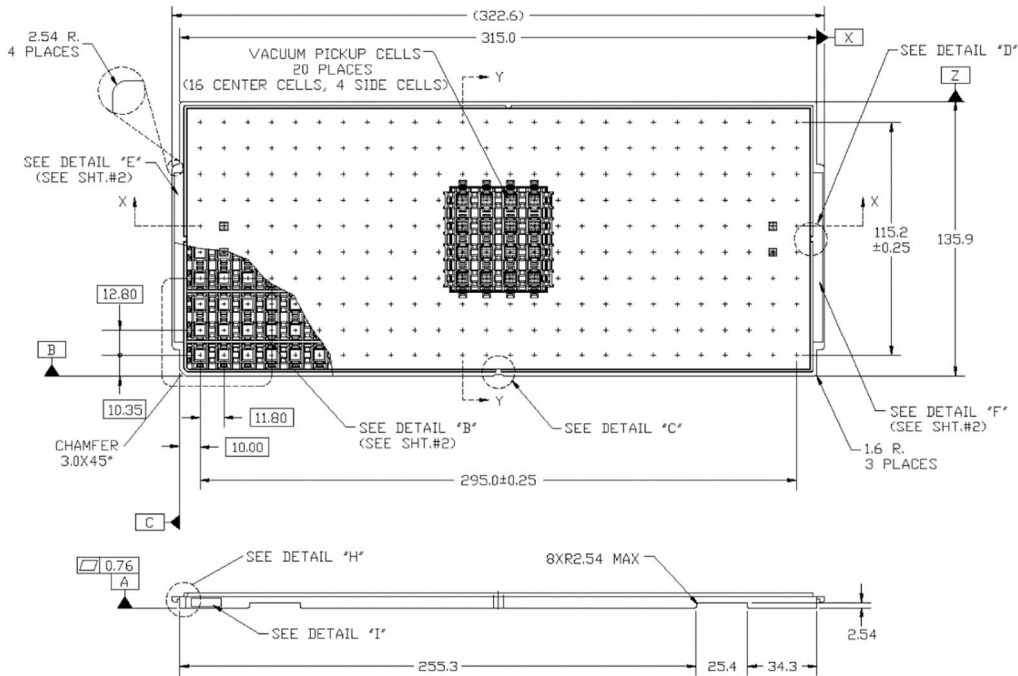

Top view position of modules within the tray.

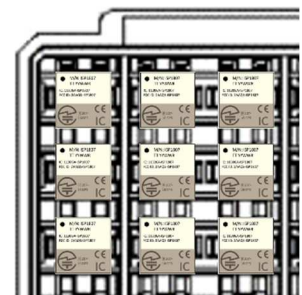

### 6.4. Tape and Reel

ISP1807 are also available in Tape & Reel. They are delivered in sealed pack with desiccant pack and humidity sensors. Reels are proposed in standard quantities of 500 units (180mm / 7" reel) or 2000 units (330mm / 13" reel) only. Please order with "RS" code packaging suffix for 500-unit reels and "R2" for 2000-unit reels.

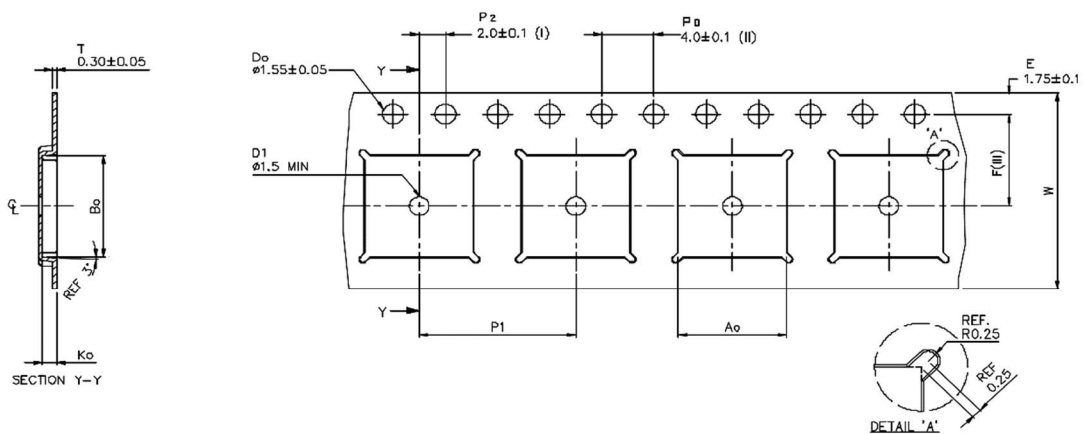

A <sub>0</sub>	8.30 +/−0.1
B <sub>0</sub>	8.30 +/−0.1
K <sub>0</sub>	1.10 +/−0.1
F	7.50 +/−0.1
P <sub>1</sub>	12.00 +/−0.1
W	16.00 +/−0.3

- (I) Measured from centreline of sprocket hole to centreline of pocket.
  - (II) Cumulative tolerance of 10 sprocket holes is ± 0.20.
  - (III) Measured from centreline of sprocket hole to centreline of pocket.
  - (IV) Other material available.
- ALL DIMENSIONS IN MILLIMETRES UNLESS OTHERWISE STATED.

Top view position of modules within the reel.

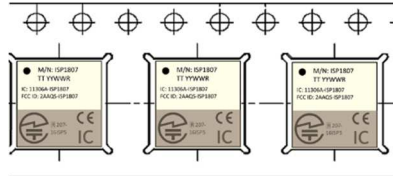

### 6.5. Ordering Information

I	S	P	1	8	0	7	-	T	T	-	Z	Z	Part Number
I	S	P	1	8	0	7		▼	▼		▼	▼	
								▼	▼		▼	▼	
							-	L	R				Long range version
							-	E	B				Evaluation Board <sup>(1)</sup>
							-	T	B				Test board <sup>(1)</sup>
							-	S	T				Standard Tray or Cut Tape
							-	J	T				Jedec Tray Packaging
							-	R	S				Reel of 500 units
							-	R	2				Reel of 2000 units

(1) Please see section 5.1 and refer to the following documentation for more information on development kit and test board:  
[http://www.insightsip.com/fichiers\\_insightsip/pdf/ble/ISP1807/isp\\_ble\\_DS1807\\_DK.pdf](http://www.insightsip.com/fichiers_insightsip/pdf/ble/ISP1807/isp_ble_DS1807_DK.pdf)  
[http://www.insightsip.com/fichiers\\_insightsip/pdf/ble/ISP1807/isp\\_ble\\_ANXXXXX.pdf](http://www.insightsip.com/fichiers_insightsip/pdf/ble/ISP1807/isp_ble_ANXXXXX.pdf)

## 7. Storage & Soldering information

---

### 7.1. Storage and Handling

- ✚ Keep this product away from other high frequency devices which may interfere with operation such as other transmitters and devices generating high frequencies.
- ✚ Do not expose the module to the following conditions:
  - Corrosive gasses such as Cl<sub>2</sub>, H<sub>2</sub>S, NH<sub>3</sub>, SO<sub>2</sub>, or NO<sub>X</sub>
  - Extreme humidity or salty air
  - Prolonged exposure to direct Sunlight
  - Temperatures beyond those specified for storage
- ✚ Do not apply mechanical stress
- ✚ Do not drop or shock the module
- ✚ Avoid static electricity, ESD and high voltage as these may damage the module

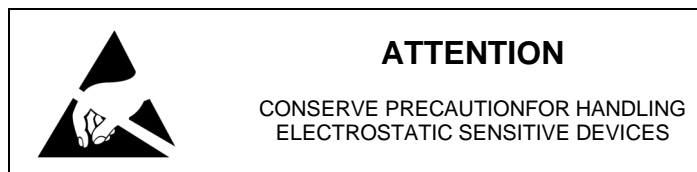

### 7.2. Moisture Sensitivity

All plastic packages absorb moisture. During typical solder reflow operations when SMDs are mounted onto a PCB, the entire PCB and device population are exposed to a rapid change in ambient temperature. Any absorbed moisture is quickly turned into superheated steam. This sudden change in vapor pressure can cause the package to swell. If the pressure exerted exceeds the flexural strength of the plastic mold compound, then it is possible to crack the package. Even if the package does not crack, interfacial delamination can occur.

Since the device package is sensitive to moisture absorption, it is recommended to bake the product before assembly. The baking process for dry packing is 24 hours at 125°C.

ISP1807 has been tested MSL-3 according to standards. After baking, modules can be exposed to ambient room conditions (approximately 30 °C/60%RH) during 168 hours before assembly on the PCB.



### 7.3. Soldering information

Recommendation for RoHS reflow process is according to Jedec J-STD-020 and 033 standard profiles.

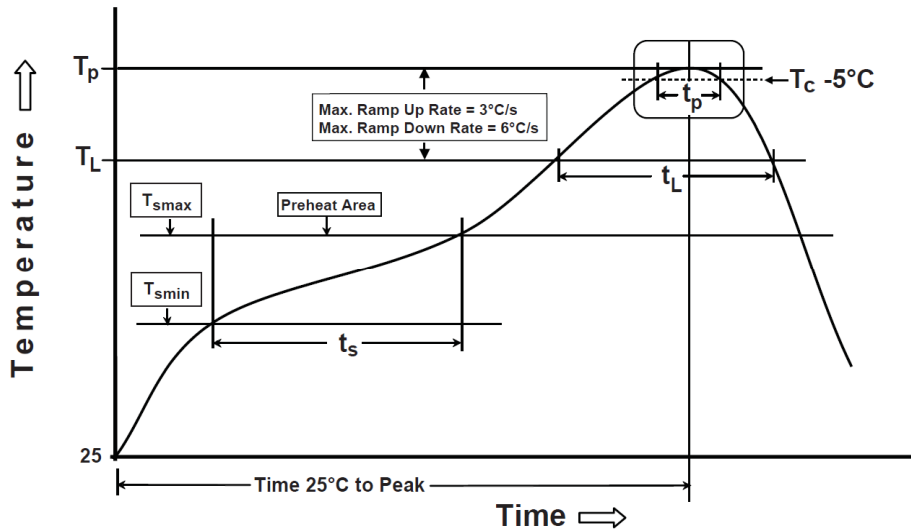

Preheat/Soak	
Temperature Min ( $T_{smin}$ )	150 °C
Temperature Max ( $T_{smax}$ )	200 °C
Time ( $t_s$ ) from ( $T_{smin}$ to $T_{smax}$ )	60-120 sec
Ramp-up rate ( $T_L$ to $T_p$ )	3 °C/sec max
Liquidous temperature ( $T_L$ )	217 °C
Time ( $t_L$ ) maintained above $T_L$	60-150 sec

Peak package body temperature ( $T_p$ )	260°C (+0/-5°C)
Classification Temperature ( $T_c$ )	260 °C
Time ( $t_p$ ) maintained above $T_c-5$ °C	30 sec
Ramp-down rate ( $T_p$ to $T_L$ )	6 °C/sec max
Time 25 °C to peak temperature	8 mn max

## 8. Quality & User information

---

### 8.1. Certifications

All below certificates can be downloaded on the website:

- + Bluetooth SIG Declaration ID n° D046560
- + CE Certified, DoC Insight SiP Ref TR201105
- + TELEC Certified, n° 020-200037
- + KCC Certification n° R-C-iNs-ISP1807
- + FCC Certification n° 2AAQS-ISP1807
- + IC Certification n° 11306A-ISP1807
- + RoHS3 and Reach compliant, Ref TR200301 and TR191101
- + Conflict Mineral Declaration available, Ref TR180701

To support customers in their application certification, Insight SiP can provide test reports on request.

### 8.2. EC – CE Certification

This device can be operated in at least one Member State without infringing applicable requirements on the use of radio spectrum.

### 8.3. USA – User information

This intends to inform how to specify the FCC ID of our module “ISP1807” on the product. Based on the Public Notice from FCC, the host device should have a label which indicates that it contains our module. The label should use below example wording or any similar wording that expresses the same meaning:

“Contains FCC ID: 2AAQS-ISP1807”

The label of the host device should also include the below FCC Statement. When it is not possible, this information should be included in the User Manual of the host device:

*“This device complies with part 15 of the FCC rules. Operation is subject to the following two conditions.  
(1) This device may not cause harmful interference  
(2) This device must accept any interference received, including interference that may cause undesired operation.  
Caution: Any Changes or modifications not expressly approved by the party responsible for compliance could void the user’s authority to operate the equipment.”*

#### 8.4. Canada – User information

This intends to inform how to specify the IC ID of our module “ISP1807” on the product. According to Canadian standards “RSS-210” and “RSS-Gen”, the host device should have a label which indicates that it contains our module. The label should use below example wording or any similar wording that expresses the same meaning:

*“Contains IC: 11306A-ISP1807”*

The label of the host device should also include the below IC Statement. When it is not possible, this information should be included in the User Manual of the host device:

*“This device complies with Industry Canada license-exempt RSS standard(s). Operation is subject to the following two conditions: (1) this device may not cause interference, and (2) this device must accept any interference, including interference that may cause undesired operation of the device.*

*Le présent appareil est conforme aux CNR d'Industrie Canada applicables aux appareils radio exempts de licence. L'exploitation est autorisée aux deux conditions suivantes : (1) l'appareil ne doit pas produire de brouillage, et (2) l'utilisateur de l'appareil doit accepter tout brouillage radioélectrique subi, même si le brouillage est susceptible d'en compromettre le fonctionnement.”*

#### 8.5. RF Exposure Information

This equipment complies with FCC/IC radiation exposure limits set forth for an uncontrolled environment and meets the FCC radio frequency (RF)Exposure Guidelines in Supplement C toOET65 and RSS-102 of the IC radio frequency (RF) Exposure rules. This equipment has very low levels of RF energy that it deemed to comply without maximum permissive exposure evaluation (MPE).

#### 8.6. Informations concernant l'exposition aux fréquences radio (RF)

La puissance de sortie émise par l'appareil de sans-fil est inférieure à la limite d'exposition aux fréquences radio d'Industry Canada (IC). Ce module a également été évalué et démontré conforme aux limites d'exposition aux RF d'IC dans des conditions d'exposition à des appareils mobiles et/ou portables.

#### 8.7. Discontinuity

Normally a product will continue to be manufactured as long as all of the following are true:

- The manufacturing method is still available.
- There are no replacement products.
- There is demand for it in the market.



In case of obsolescence, Insight SiP will follow Jedec Standard JSD-48. A Product Discontinuation Notice (PDN) will be sent to all distributors and made available on our website. After this, the procedure goes as follows:

- Last Order Date will be 6 months after the PDN was published.
- Last Shipment Date will be 6 months after Last Order Date, i.e. 12 months after PDN.

## **8.8. Disclaimer**

Insight SiP's products are designed and manufactured for general consumer applications, so testing and use of the product shall be conducted at customer's own risk and responsibility. Please conduct validation and verification and sufficient reliability evaluation of the products in actual condition of mounting and operating environment before commercial shipment of the equipment. Please also pay attention (i) to apply soldering method that don't deteriorate reliability, (ii) to minimize any mechanical vibration, shock, exposure to any static electricity, (iii) not to overstress the product during and after the soldering process.

The products are not designed for use in any application which requires especially high reliability where malfunction of these products can reasonably be expected to result in personal injury or damage to the third party's life, body or property, including and not limited to (i) aircraft equipment, (ii) aerospace equipment, (iii) undersea equipment, (iv) power plant control equipment, (v) medical equipment, (vi) transportation equipment, (vii) traffic signal equipment, (viii) disaster prevention / crime prevention equipment.

The only warranty that Insight SiP provides regarding the products is its conformance to specifications provided in datasheets. Insight SiP hereby disclaims all other warranties regarding the products, express or implied, including without limitation any warranty of fitness for a particular purpose, that they are defect-free, or against infringement of intellectual property rights. Insight SiP customers agree to indemnify and defend Insight SiP against all claims, damages, costs and expenses that may be incurred, including without any limitation, attorney fees and costs, due to the use of products.